

ВЫВОДНОЙ СВЕТОДИОД КРУГЛЫЙ

ARL-3014EGC/3L

FEATURES

- Two chips are matched for uniform light output, wide viewing angle.
- Long life — solid state reliability.
- I.C. compatible.
- Low power consumption.
- Pb free.

DESCRIPTIONS

- The LED lamps contain two integral chips and are available as both bicolor and bipolar types.
- The Bright Red and Green light is emitted by diodes of GaAsP/GaP and GaAsP/GaP respectively.
- Type of bipolar lamps are both White Diffused and Color Diffused while the bicolor are White Diffused.

APPLICATIONS

- Status indicators.
- Commercial use.
- Advertising signs.
- Back lighting.

DEVICE SELECTION GUIDE

LED Part No.	CHIP		Lens Color
	Material	Emitted Color	
ARL-3014EGC/3L	GaAsP/GaP	Red	Water Clear
	GaAsP/GaP	Green	



3 mm



CLEAR



Red/Yellowish



USAGE NOTES:

Surge will damage the LED.

When using LED, it must use a protective resistor in series with DC current about 20 mA.



ATTENTION!
ELECTROSTATIC SENSITIVE DEVICES.
OBSERVE PRECAUTIONS FOR HANDLING.

PACKAGE DIMENSIONS

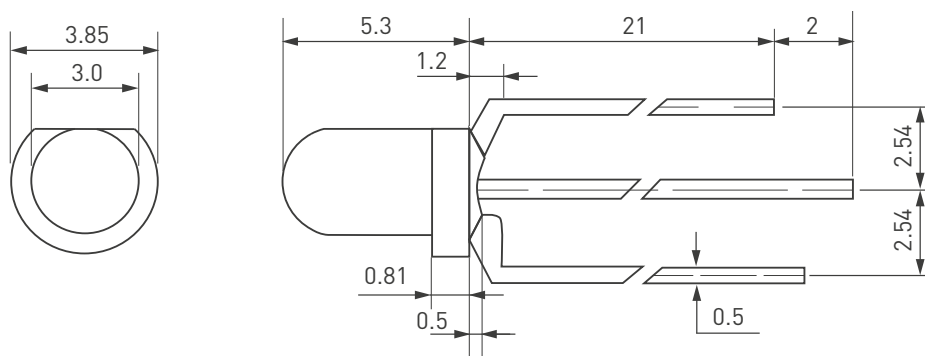

Unit: mm.

Notes:

Other dimensions are in millimeters, tolerance is 0.25 mm except being specified.

Protruded resin under flange is 1.5 mm Max LED.

Bare copper alloy is exposed at tie-bar portion after cutting.

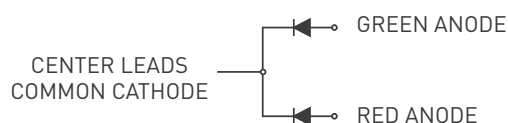

ELECTRO-OPTICAL CHARACTERISTICS ($T_A = +25^\circ\text{C}$)

Parameter	Symbol	Device	Min.	Typ.	Max.	Unit	Test Condition
Luminous Intensity	I_v	Red	80	—	120	mcd	If=20mA
		Green	50	—	100		
Viewing Angle	$2\theta_{1/2}$	Red	—	35	—	Deg	Note 1
		Green	—	—	—		
Peak Emission Wavelength	λ_P	Red	630	—	640	nm	If=20mA
		Green	565	—	575		
Spectral Line Half-Width	$\Delta\lambda$	Red	15	20	25	nm	If=20mA
		Green	15	20	25		
Forward Voltage	V_F	Red	1.9	—	2.3	V	If=20mA
		Green					
Reverse Current	I_R	Red	—	—	10	μA	VR=5V
		Green					

Note:

- Luminous intensity is measured with a light sensor and filter combination that approximates the CIE eye-response curve.
- $\theta_{1/2}$ is the off-axis angle at which the luminous intensity is half the axial luminous intensity.

TYPICAL ELECTRO-OPTICAL CHARACTERISTICS CURVES

Relative Intensity VS Wavelength

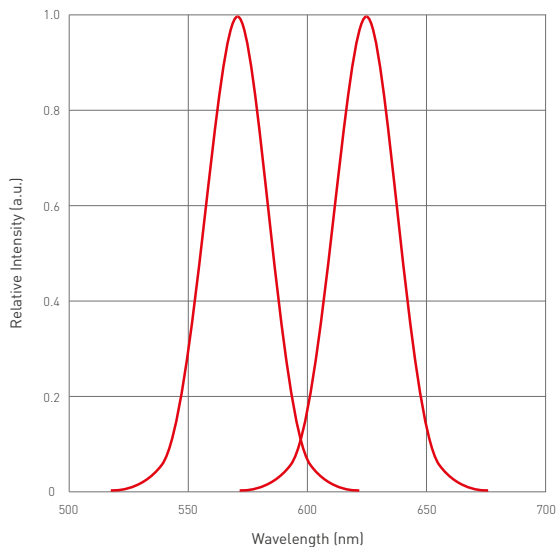

Forward Current VS Forward Voltage

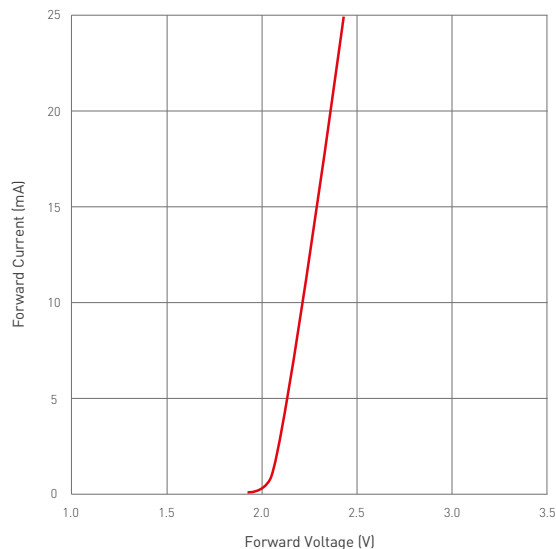

Relative Intensity VS Ambient Temp



Relative Intensity VS Forward Current

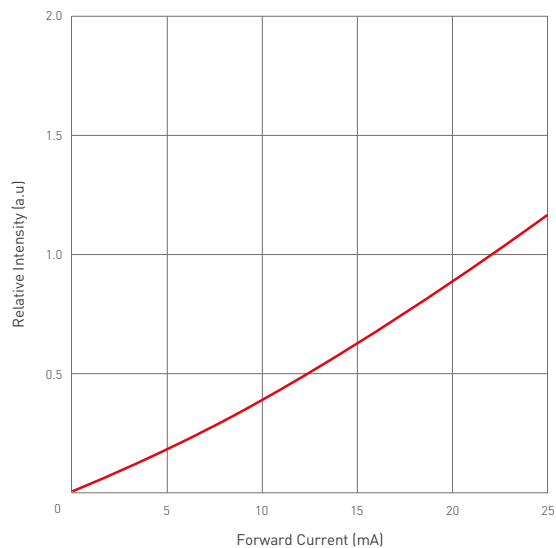

Forward Current VS Ambient Temp

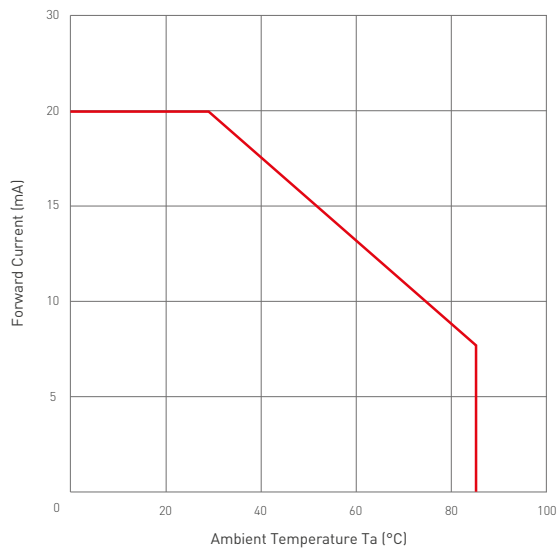

Radiation Characteristics

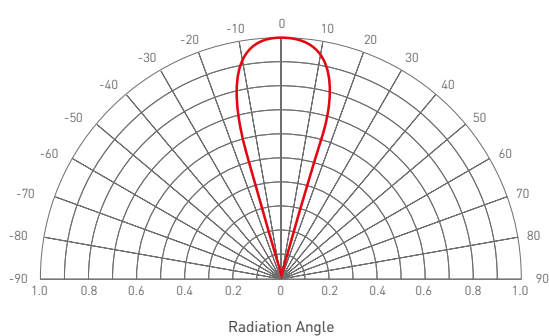

NOTES

1. Above specification may be changed without notice. HYLEd will reserve authority on material change for above specification.
2. When using this product, please observe the absolute maximum ratings and the instructions for using outlined in these specification sheets. HYLEd assumes no responsibility for any damage resulting from use of the product which does not comply with the absolute maximum ratings and the instructions included in these specification sheets.
3. These specification sheets include materials protected under copyright of HYLEd corporation. Please don't reproduce or cause anyone to reproduce them without HYLEd's consent.